

OVERLY DOOR COMPANY

574 WEST OTTERMAN STREET
GREENSBURG, PA 15601-0070
TELEPHONE: (724) 834-7300
FAX: (724) 830-2871

BULLET RESISTANT WINDOW DATA SHEET

CUSTOMER: _____ APPROVED BY: _____
 JOB: _____ DATE: _____
 LOCATION: _____ SALES ORDER: _____ ITEM: _____
 CUSTOMER PO: _____ MARK NUMBER 1: _____ ADDITIONAL MARKS: _____

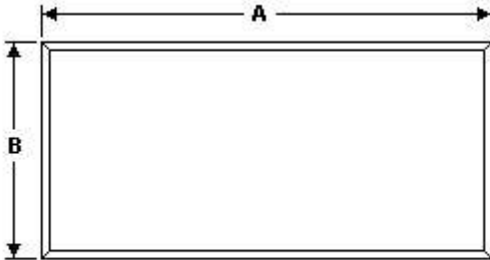

ELEVATION

WINDOW INFORMATION

MODEL NUMBER: _____
 MATERIAL: _____
 PRIMER: _____

UL 752 LEVEL

LEVEL 1 LEVEL 5
 LEVEL 2 LEVEL 6
 LEVEL 3 LEVEL 7
 LEVEL 4 LEVEL 8

GLASS INFORMATION

GLASS PROVIDED BY: OVERLY OTHERS
 IF BY OTHERS, GLASS THICKNESS _____"
 NOTE: If glass is provided by others, Overly must review the size and configuration in order to meet the bullet resistant rating.

FRAME INFORMATION

FRAME CONFIGURATION: _____
 FRAME ANCHORAGE: _____
 (A) OVERALL FRAME WIDTH: _____"
 (B) OVERALL FRAME HEIGHT: _____"
 (C) JAMB DEPTH: _____"
 (D) WALL THICKNESS: _____"
 (E) JAMB TRIM: _____"
 (F) HEAD TRIM: _____"
 (G) SILL TRIM: _____"
 ROUGH OPENING: _____"
 WALL TYPE:
 MASONRY/CMU CHANNEL/TUBE STEEL
 METAL STUD * WOOD STUD
 *SPLIT AND EWA ONLY: Wood blocking must be placed behind metal studs.

FIRE RATING*

NO FIRE RATING AVAILABLE FOR BULLET RESISTANT WINDOWS

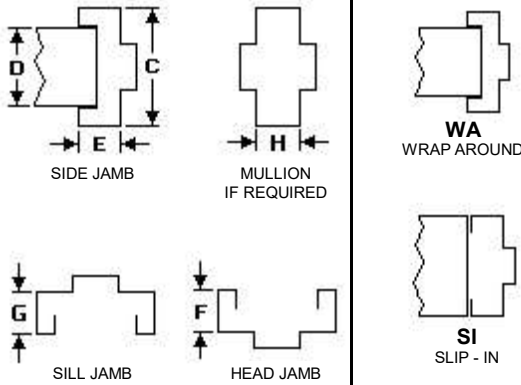

FRAME PROFILE

FRAME CONFIGURATION

MULLION INFORMATION

VERTICAL MULLION REQUIRED?: YES NO IF YES, SPECIFY QUANTITY: _____
 HORIZONTAL MULLION REQUIRED?: YES NO IF YES, SPECIFY QUANTITY: _____
 (H) MULLION TRIM SIZE: _____"

REMARKS:

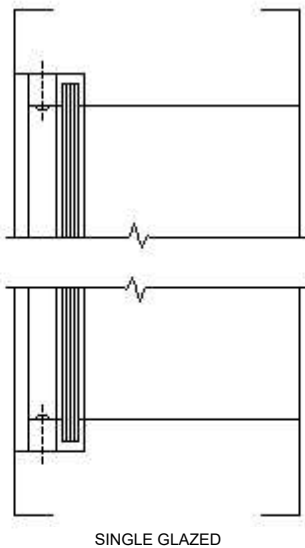

SINGLE GLAZED

NOTE:

FRAME AND GLASS SIZES ARE SHOWN IN A GENERAL CONFIGURATION. ACTUAL FRAME AND GLASS SIZES DEPEND ON THE BULLET RESISTANT RATING.

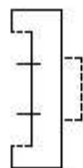

NSA
NEW STUD WALL ANCHOR

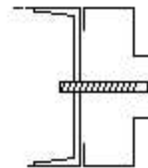

CF-BLT
BOLT-IN CHANNEL IRON

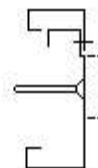

SPLIT
SPLIT FRAME

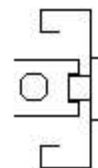

NMA
NEW MASONRY ANCHOR

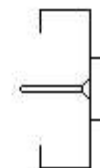

EWA
EXISTING WALL ANCHOR

FRAME ANCHORAGE