

AVAILABLE SOUND CONTROL SILL SYSTEMS FOR 2-1/4" THICK WOOD ACOUSTICAL DOOR WITH SUPER "H" DOOR BOTTOM

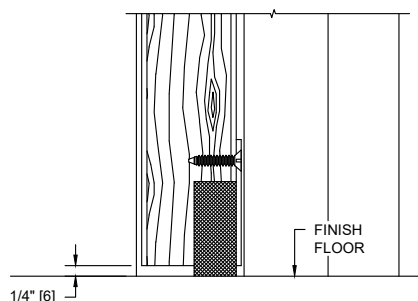

SHOWING SUPER "H" DOOR BOTTOM WITH SMOOTH FINISHED FLOOR CONDITION

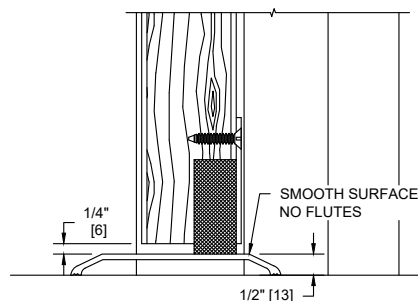

SHOWING SUPER "H" DOOR BOTTOM WITH ALUMINUM THRESHOLD

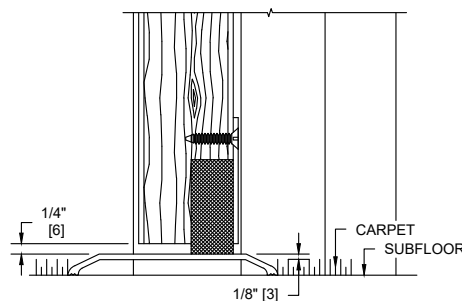

SHOWING SUPER "H" DOOR BOTTOM WITH ALUMINUM THRESHOLD CARPET BOTH SIDES

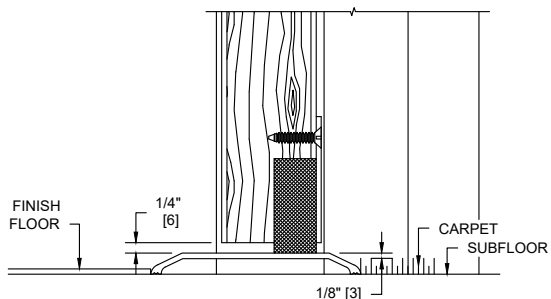

SHOWING SUPER "H" DOOR BOTTOM WITH ALUMINUM THRESHOLD CARPET STOP SIDE

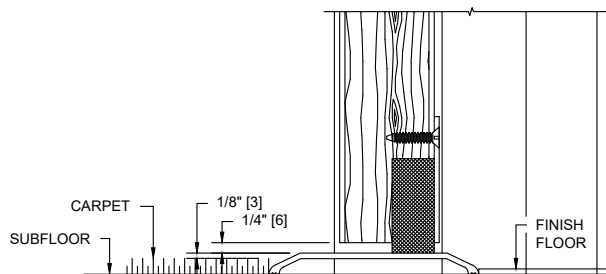

SHOWING SUPER "H" DOOR BOTTOM WITH ALUMINUM THRESHOLD CARPET HINGE SIDE

NOTES:

1. All models of Overly Sound Retardant doors must have a smooth, level surface for the door bottom to seal against. If carpeting is used, a threshold must be installed. The height of the threshold should be at least equal to and preferably 1/8" higher than the carpet. It is recommended that the threshold be installed against the sub-floor and run the carpet up to the threshold. Thresholds are to be set in a good grade of acoustical sealant. Do not install the threshold on top of the carpeting.
2. The use of fluted and/or abrasive coated thresholds will cause premature wearing and failure of the door bottom neoprene, and are not recommended.
3. The position of the thresholds should be such that the leading edge of the threshold be placed no deeper than the door side trim of the frame.
4. For doors equipped with an automatic door bottom and standard hinges the thresholds requirements are exactly the same