

574 West Otterman Street • Greensburg, PA • 15601
Toll Free: (800) 979-7300 • Local: (724) 834-7300
Fax: (724) 830-2871 • Email: overly@overly.com



Installation Instructions For Overly Acoustical Window

Model STC 5592278

General Information

The proper performance of most manufactured building products depends not only on how they are made, but how they are installed. This is particularly true of **Acoustical Window** units. Anyone acquainted with building construction knows that the proper installation of the frames is an operation that requires great skill and care. Even the best designed and most carefully made frames, if improperly installed, will not function or perform to their intended maximum effectiveness. Additionally, **Acoustical Window** openings require careful installation of the frame and glass panel perimeter sealing systems in order to obtain the desired level of acoustical performance.

Overly Door Company is concerned that our product is properly handled and protected after delivery, and that the necessary care and skills are exercised in the setting of our **Acoustical Window** frames. It is important to all concerned, therefore, that attention be given to the essential requirements of good practice in field installation work. Use of these installation instructions along with the approved shop drawings, along with your attention to good workmanship will provide the proper installation and operation of Overly Acoustical Windows.

Delivery and Receiving of Materials

Acoustical Windows are fabricated in accordance with shop drawings that have been approved by the architect or design engineer.

Should any material be damaged in shipment, claims should immediately be filed by the receiving party, who should notify the delivering carrier's regional office by telephone or in writing, requesting inspection of the damaged material. If desired, Overly Door will cooperate by furnishing copies of shipping papers or other pertinent information to help expedite the claim. Accepted materials become the customer's responsibility to protect and store accordingly.

If a claim is to be made for any error or deficiency in the materials supplied, it is imperative that Overly be notified in writing before initiating any corrective action in the field. Overly Door has its own field representatives who are qualified not only to do expert repair work but to determine whether the fault lies with the manufacturer or with some other party.

On-Site Storage

Improper storage of **Acoustical Windows** at the construction site often results in the deterioration of the shop primer coat of paint. Such deterioration is a continuing source of aggravation to all concerned.

Particular attention must be given to steel products which are to be stored having only one coat of shop primer if corrosion is to be avoided. Because the protective shop primer must be porous to properly receive and hold top coats, water or moisture in contact with prime coated steel will seep through to the steel by capillary action. An electrolytic action then follows, resulting in corrosion and causing the paint to lose adhesion. The presence of oxygen at the water-air interface behind the loosened paint film accelerates corrosive action and further prime coat deterioration.

Manufacturers of metal acoustical windows have found that one week of exposure to water because of improper storage is equivalent to at least a year of outdoor exposure to the elements.

It is imperative that those parties who are responsible for the storage of primed metal work at the job-site be carefully instructed as to proper storage procedures. All ferrous metal products should be stored where they are least likely to come in contact with or be exposed to water or moisture.

The following steps should always be observed when storing **Acoustical Windows** at the job-site:

- A. Store all materials in a dry area under cover.
- B. Place all material on planking or blocking at least 4" off of the ground, 2" off of slab or paved area.
- C. Do not stack material flat. Store with frames in an upright position.
- D. Provide, by means of wood or styrofoam strips, a space of at least 1/4" between all units, to allow air to circulate between them.

- E. Do not permit cardboard or paper to become wet and come in contact with the frames. If this should occur, remove them immediately.

Uncrating Instructions

Depending on the size of your particular order and the manner in which items required for the window installation were ordered, the crate which you have received may contain one, two or several acoustical window units. The quantity and type of items provided by Overly can be found on the packing list located on the outside of the crate. Many times, the glass required is provided by an outside source and should be coordinated with the Overly framing system. As you uncrate, you will be required to locate the following items for a complete installation:

- A. Frame - identification information on the frame can be found on a small white tag located on one of the frame jambs. This information includes Overly order number and unit mark number.
- B. Glass - This acoustical window model requires one piece of 1/2" thick Acousta-pane 39 or equal laminated glass and 3/4" thick Acousta-pane 43 or equal laminated glass. Glass may or may not have been provided by Overly. Check the shop drawings and packing lists to verify if supplied by Overly.
- C. Frame Gasketing System - this acoustical window model requires the use of a two different size special "zipper" type neoprene gasketing material for the glazing of the unit. These preformed "zipper" gaskets are two piece systems that consist of a main "H" shaped seal and separate locking strips. The main "H" seal is a continuous unit with preformed integral corners, custom sized to fit the metal framing assembly.
- D. "Zipper" Gasket Installation Tool - An installation tool for the insertion of the lockstrip into the "H" shaped seal is provided. Other tools are available at additional cost, if necessary, to further ease the glass installation. These items are shown on the last page of these instructions.
- E. Frame anchors for appropriate wall construction have been provided. Check the shop drawings and packing lists to verify type supplied by Overly.

Frame Installation Procedure

The frame assembly provided consists of a 4-sided welded unit that was factory inspected prior to shipment to assure that they are square and that no jamb twists have occurred during their fabrication. To minimize misalignment or other damage during shipment, the frames are packed and loaded onto the carrier by personnel experienced in frame packaging. However, in spite of these precautions, the frames can and sometimes do arrive at the jobsite with minor deviations. Should this occur, most out-of-square and misalignment problems can be readily corrected during installation.

Frame anchorage systems are custom designed to accommodate individual project opening requirements to suit specified wall conditions. Therefore, it is necessary to refer to the approved shop drawings for each individual frame for the method of anchorage. The four types of anchorage covered by these instructions include:

1. Built-in masonry
2. Built-in drywall with wood or channel studs
3. Bolt-in masonry
4. Bolt-in drywall with wood or channel studs

At this time, review the shop drawings for the openings and proceed to the type of installation required. Regardless of the anchorage system required, the installation guidelines must be adhered to. At anytime during the installation of the product, if questions arise, call **Overly Door Company at 724-834-7300**.

1. Built-in Masonry Partition

- A. Using some type of triangular support and bracing device that will securely hold the frame in the exact location and alignment required for proper installation. Usually such bracing is made of wood. However, metal "jacks" or supporters designed specifically for this purpose are commercially available, and their use is recommended.
- B. Cut 3/4" thick temporary wood spreaders and locate at 1/3 points across the short dimension of frame to maintain proper opening size during installation.

- C. Check that the frame is square and aligned by measuring the diagonal dimensions and "cross string" the frame to insure that the jambs are properly set. (See Figure 1).
- D. While protecting the frame from accidental abuse, build walls to the frame utilizing the strap anchors attached to the frame, making sure that proper frame alignment is maintained.

Note: As the walls are being built, the frame must be grouted full to ensure maximum acoustical performance. Extreme caution must be exercised while performing this operation to make sure the head does not sag nor the jambs or sill be allowed to bow.
- E. After the frame is permanently built into the wall, with all strap anchors installed and cement and/or grout set, remove the wood spreaders.
- F. Caulk frame continuously around perimeter of frame on both sides as shown in Figure 2.

Now Proceed to "Installation of Glass" section.

2. Built-in Drywall Partition

- A. Using some type of triangular support and bracing device that will securely hold the frame in the exact location and alignment required for proper installation. Usually such bracing is made of wood. However, metal "jacks" or supporters designed specifically for this purpose are commercially available, and their use is recommended.
- B. Cut 3/4" thick temporary wood spreaders and locate at 1/3 points across the short dimension of frame to maintain proper opening size during installation.
- C. Check that the frame is square and aligned by measuring the diagonal dimensions and "cross string" the frame to insure that the jambs are properly set. (See Figure 1).

Note: At this point, the frame must be packed full with 6 to 12 PCF density mineral wool in the form of blanket or board type, to ensure the maximum acoustical performance of the opening.
- D. While protecting the frame from accidental abuse, build walls to the frame utilizing the anchorage shown on the approved shop drawings, making sure that proper frame alignment is maintained. Due to weight of the final installed unit, provide adequate stud bracing under sill of frames to support weight.
- E. Caulk frame continuously around perimeter of frame on both sides as shown in Figure 2.

Now Proceed to "Installation of Glass" section.

3. Bolt-in Masonry Partition

Note: Masonry openings that are to receive preassembled welded frames must be accurately constructed. They should be 1/2" wider than the overall frame width dimension and 1/2" higher than the overall frame height, to provide a clearance on all sides of 1/4" to allow for shimming during installation.

Note: At this point, check the approved shop drawings or architects plans to see if the frame is to be grouted full or packed with mineral wool. If the frame is to be grouted full, proceed to **Step A**. If the frame must be packed full, pack all frame cavities full at this time using 6 to 12 PCF density mineral wool in the form of blanket or board type, to ensure the maximum acoustical performance of the opening.

- A. Shim frame as required to maintain the tolerances shown in Figure 1 and securely anchor the frame to the wall using the anchor bolts of type and dimensions specified on the approved shop drawings and supplied by Overly
- B. Check that the frame is square and aligned by measuring the diagonal dimensions and "cross string" the frame to insure that the jambs are properly set. (See Figure 1).

Note: If the frame is to be grouted in place, grout at this time with Gold Bond brand grout or equal.

Extreme caution must be exercised while performing this operation to make sure the head does not sag nor the jambs bow. Support frame head and jambs with adequate bracing, removing only after grout has had sufficient time to cure.

- C. Caulk frame continuously around perimeter of frame on both sides as shown in Figure 2.

Now Proceed to "Installation of Glass" section.

4. Bolt-in Drywall Partition

Note: Drywall openings that are to receive preassembled welded frames must be accurately constructed. They should be 1/2" wider than the overall frame width dimension and 1/2" higher than the overall frame height above the finished floor, to provide a clearance on all sides of 1/4" to allow for shimming during installation.

Note: At this point the frame must be packed full, pack all frame cavities at this time using 6 to 12 PCF density mineral wool in the form of blanket or board type, to ensure the maximum acoustical performance of the opening.

- A. Shim frame as required to maintain the tolerances shown in Figure 1 and securely anchor the frame to the wall using the anchor bolts of type and dimensions specified on the approved shop drawings as supplied by Overly.
- B. Check that the frame is square and aligned by measuring the diagonal dimensions and "cross string" the frame to insure that the jambs are properly set. (See Figure 1).
- C. Caulk frame continuously around perimeter of frame on both sides as shown in figure 2.

Now Proceed to "Installation of Glass" section.

Installation of Glass

Note: Prior to glazing window, all finish painting should be completed. Please read additional information included at the end of these instructions regarding "Installation Procedures for Stanlock Gaskets".

- A. Locate the "H" shaped continuous main seal gasket with a 1/2" groove around the outside of the seal. Place this gasket over the 1/2" wide bar attached to the frame. A rubber mallet may be required to pound the gasket against the frame to properly seat the seal. See Figure 2.

Note: Before installing the seal, locate lockstrip groove so that it is on the trim side of the frame.

- B. Install the 1/2" thick laminated glass into the pocket of the main "H" shaped seal.
- C. Locate "zipper" lockstrip and lockstrip insertion tool. Notice on the main seal, the four corners require no lockstrip. Start with lockstrip at one corner and install with tool provided by inserting it into the groove and "push" the tool away from you. The pushing action will "spread the "H" seal to accept the lockstrip. The use of soapy water or silicon spray will ease the installation of the lockstrip. Cut the lockstrip to suit, and repeat on remaining three sections.
- D. Run bead of caulking around the "zipper" side of gasket as shown on Figure 2, Detail "A".
- E. Locate the "H" shaped continuous main seal gasket with a 3/4" groove around the outside of the seal. Place this gasket over the 3/4" wide bar attached to the frame. A rubber mallet may be required to pound the gasket against the frame to properly seat the seal. See Figure 2.

Note: Before installing the seal, locate lockstrip groove so that it is on the trim side of the frame.

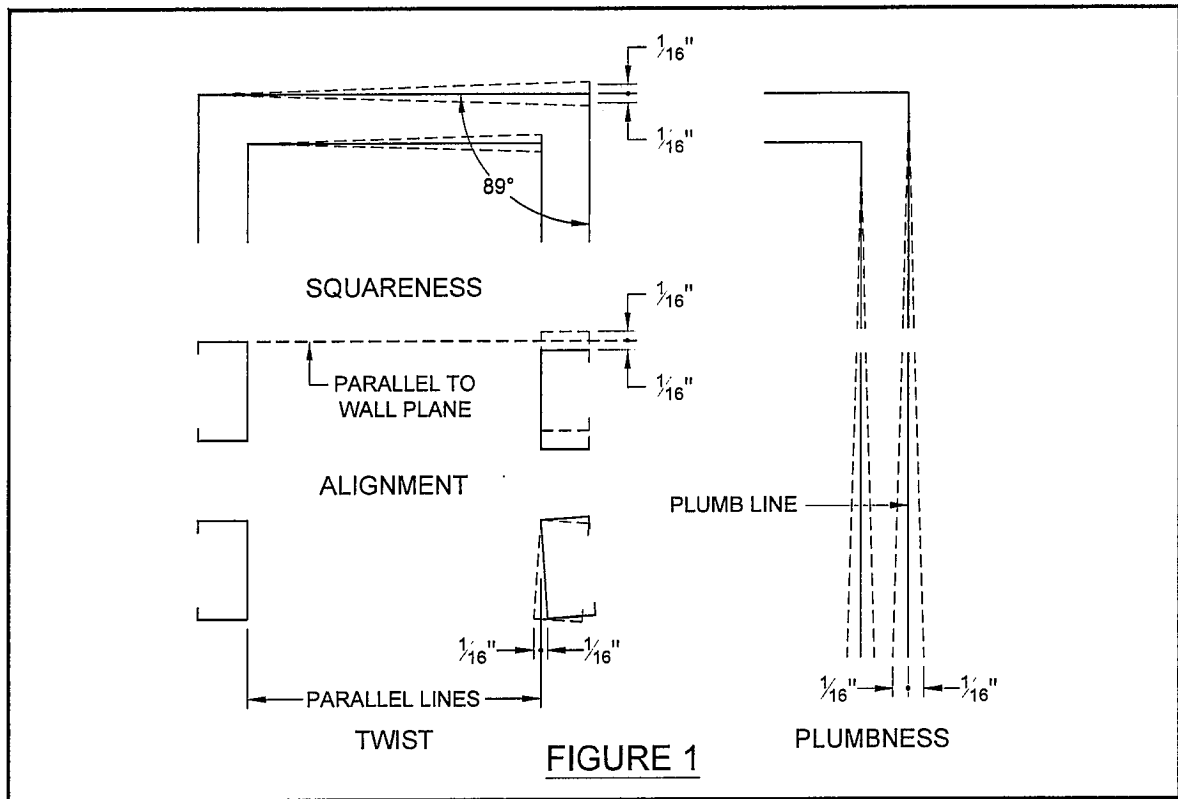

- F. Install the 3/4" thick laminated glass into the pocket of the main "H" shaped seal.
- G. Insert lockstrip as stated in Step C.
- H. Run bead of caulking around the "zipper" side of gasket as shown on Figure 2, Detail "B".

Optional Purge Ports

If purge ports have been provided for this window unit, the following instructions are to be followed, if moisture is present between the panes of glass. If moisture is not present, skip this section. Purging **is not** required for acoustical rating.

- A. Once the frame has been installed, and the airspace that surrounds both sides of the unit has been allowed to reach its normal temperature, moisture may form between the two panes of glass. If this occurs, purging is required.
 - B. Remove both purge port plugs located on trim of one side of the frame. Each purge port is a 1/4" pipe fitting.
 - C. Choose one of the purge ports and hook up a nitrogen gas bottle to the port by a hose and proper fittings. Begin releasing the gas into the chamber and allow all of the airspace to be replaced with the gas. This takes approximately 10 minutes for a standard size window.
- Note:** Caution must be exercised not to allow the exhaust port to become blocked. This will cause the gas pressure to build-up between the glass panels.
- D. Once the moisture disappears, replace both purge port plugs.

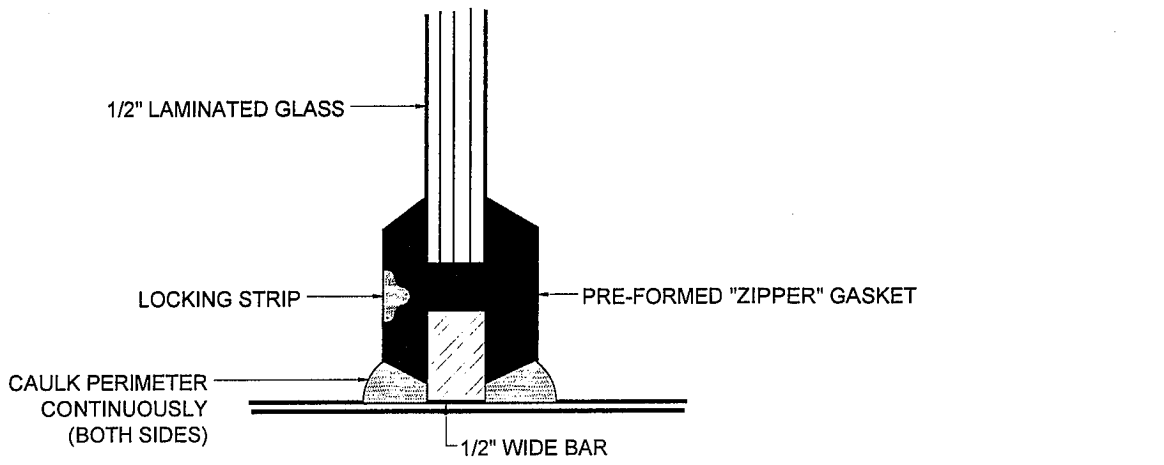

DETAIL "A"

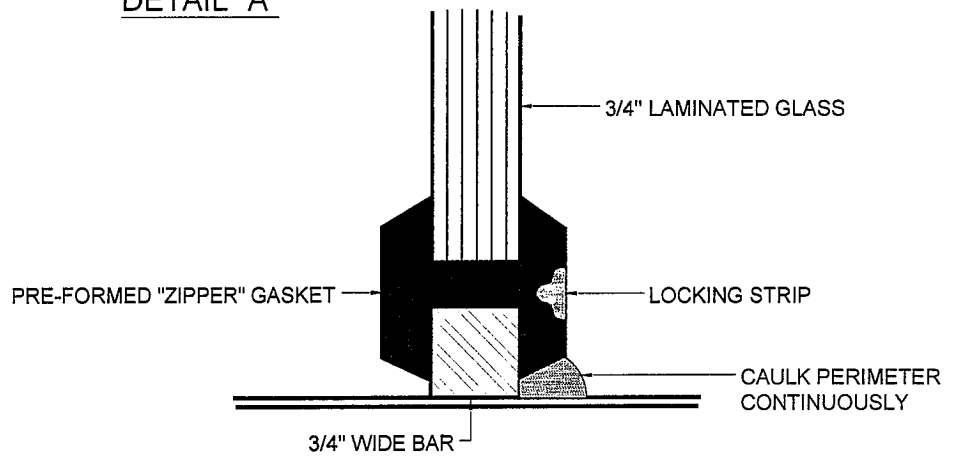

DETAIL "B"

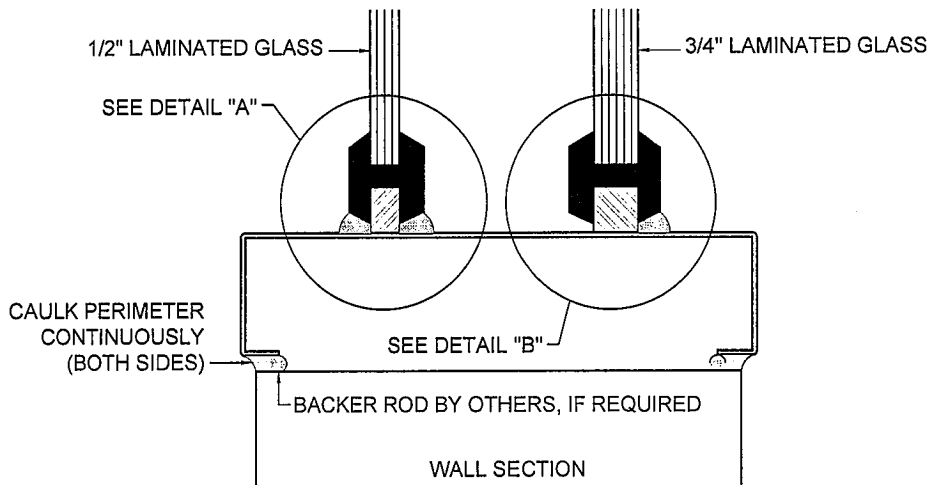

FIGURE 2

Installation Procedures For



STANLOCK[®]
LOCKSTRIP GASKET SYSTEMS

BEFORE INSTALLATION

1. Preparation of Gaskets for Installation:

a. Unpack from cartons and lay flat or hang from racks in a warm area or heated room to allow recovery of shapes. It is advisable that this be done several hours prior to installation.

b. During cold weather, generally 50°F or below, the gaskets should be permitted to warm long enough to permit full recovery of any deformations and to allow a state of flexibility and resiliency to be attained. It may be desirable to provide heat to the gaskets, in an enclosed area, to facilitate normal installation. StanLock gaskets may be heated to a maximum of 200° F without any damaging effects. Do not expose gaskets to direct flame when warming.

2. Frame or Window Opening Requirements

a. Openings should be measured to insure proper dimensions and examined for alignment, out of tolerance, out of plane and sealing surface conditions. StanLock gaskets should not be installed if any deficiencies are noted within the framing system.

b. Specific requirements and tolerances for various frame systems and gasket parts are included in the current StanLock catalog, contained in SWEETS CATALOG FILE under 08900/STA.

3. Glass or Panel Requirements

a. Glass or panel materials should be measured to assure proper sizing for the installation intended. Specific requirements for proper sizing are included in the current StanLock catalog.

b. When the edges of glass products are excessively sharp or flared, grinding or edge beveling may be desirable to prevent damage to the gaskets during installation. Nipping the top corners of the glass (before fabrication of insulated lites) may also ease glazing. Refer to the glass manufacturer's recommendations for acceptable edge treatment of specific types of glass.

c. It is recommended that where StanLock gaskets are to be used with an insulating glass product, the glazing system additionally incorporate setting blocks, weep holes and/or supplementary sealants, as may be required by the glass manufacturer.

Gasket Accessories

a. Weep holes can often be included within the gasket during the manufacturing process when proper provisions for them have been made during design or detailing. In some instances, weep holes must be field applied.

b. Proper setting block length can be determined by the application of a simple rule of thumb: one (1) lineal inch of setting block for each square foot of glass area. This combined length is then divided into two equal blocks located at quarter points of the sill condition.

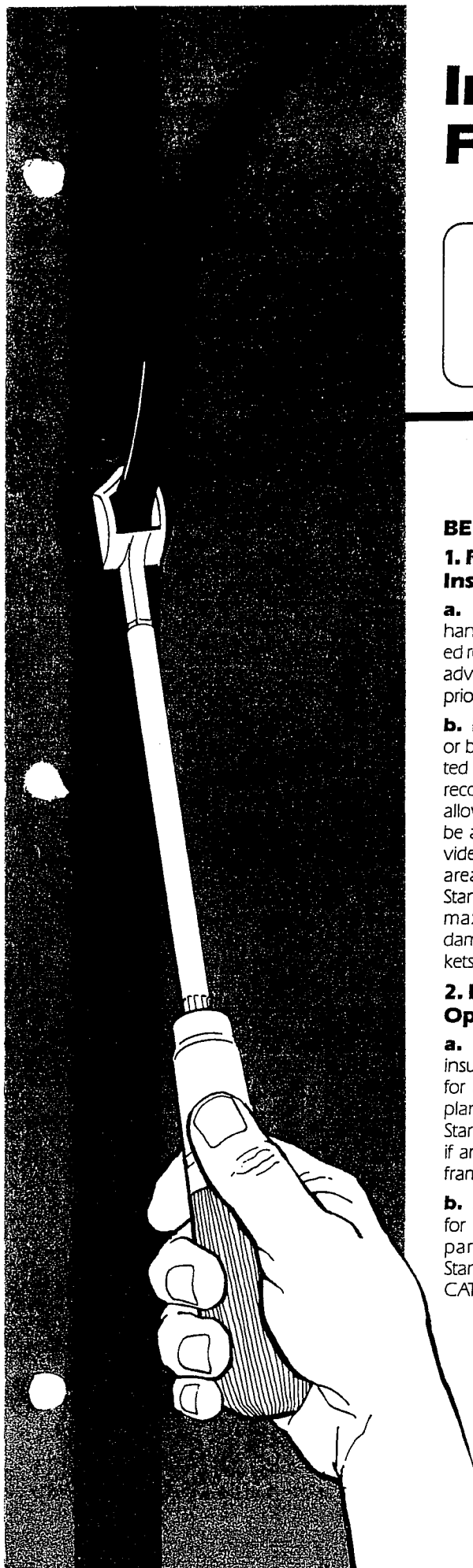

INSTALLATION INSTRUCTIONS:

H-Type Gaskets



1. Insert gasket corners into frame, then work remainder of gasket onto frame by starting from each corner and working toward center. (Fig. A)

2. Make sure gasket is firmly seated against frame.



Spline/Reglet Gaskets

1. Insert gasket corners into groove or reglet. Start each leg of the gasket into the groove of reglet, equalizing the excess "crowd" over the length of the leg.

2. Drive gasket into place, using caution not to over drive or seat too deeply. It is only essential that the shoulders of the gasket make firm contact with the sealing surface. Gaskets driven too far into the receiver will be somewhat closed and make installation of glass and locking strip difficult.

Fig. A

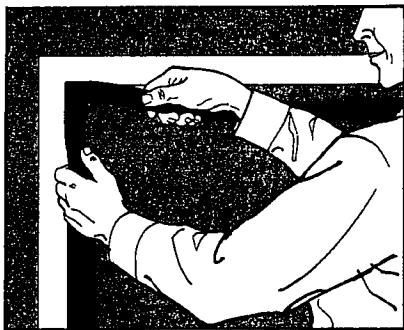

Curtainwall/ Ribbonwall Ladders

1. After determining the proper orientation, place the ladder or grid against the receiving framework and begin insertion into metal splines at successive intersections. Starting from the top, bottom or either side, equalize excess "crowd" over the length of each leg. Butt ends of adjacent ladder gaskets should be coated with a one-part urethane or a butyl rubber sealant (black color), joined together, then pushed into position in the spline groove or onto the H-frame. "Crowd" material should then be installed to cause the installed butt joint to compress.

2. Make sure all straight lengths and joints are firmly seated.

All Types — H & Spline

3. Check that gasket lips are not curled under.

4. Lubricate the gasket lips adequately with StanLock Lubricant on glass channel side of gasket to facilitate insertion of glass.

5. Enter the bottom edge of glass or panel into gasket about 6"-8" above bottom of the gasket by deflecting sealing lips at sides and then lower glass or panel into bottom channel of the gasket. (Fig. B)

Fig. B

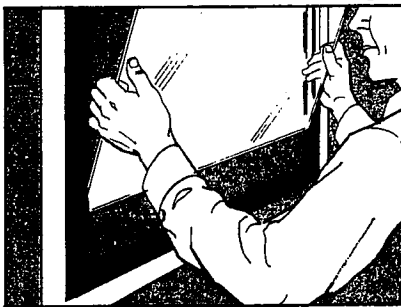

6. Insert a non-metallic spatula between the edge of the glass and the sealing lip on each side, starting at the bottom of the installation. Proceed upward with both spatulas at the same time while simultaneously pushing the glass or panel inward. Use care to prevent cutting of gasket sealing lips by glass edges. (Fig. C)

Fig. C

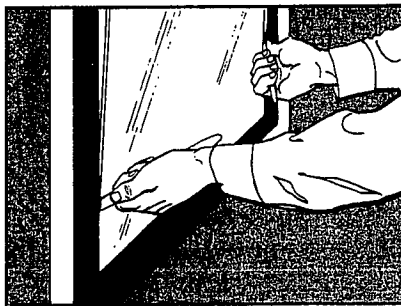

7. When top gasket corners are reached, using two spatulas, lift gasket corners over edge of glass. (Fig. D)

Fig. D

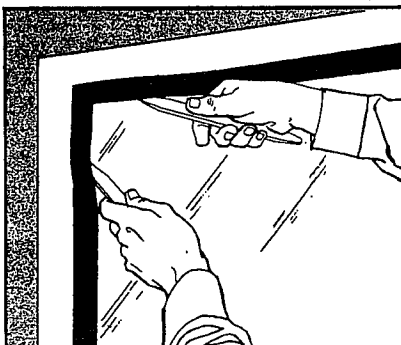

8. Center glass or panel in gasket for uniform edge coverage on both sides of installation. If shims or setting blocks are required to position glass, the length of the neoprene shims or blocks should be sufficiently long so that the gasket is not distorted. (Approximately one (1) linear inch of setting block is recommended for each square foot of glass area.)

To ease glazing, place setting blocks *after* glass is installed in glazing pocket.

9. Cut lockstrip for sill to a length of approximately 2"-3" longer than sill dimension. Thoroughly lubricate lockstrip and lockstrip cavity using StanLock lubricant. Thread lockstrip into eye of lockstrip tool. Start installation of lockstrip at sill leaving an excess of lockstrip at both ends. Repeat procedure for jambs and head. (Fig. E).

Fig. E

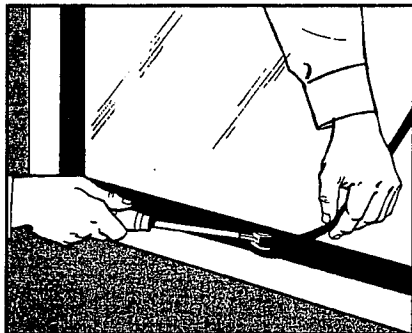

10. The lockstrip ends should be trimmed approximately 1/8" to 1/4" longer than the lockstrip cavity and crowded into place using a non-metallic tool. Either an angle miter or square butt joint is acceptable. (Fig. F).

Fig. F

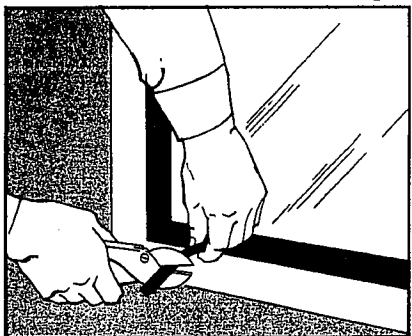

Completing the Glazing Installation:

a. To straighten the sightline, bump the gasket against the frame using a block of wood.

b. Push lockstrip into cavity with spatula where complete insertion was not accomplished.

c. Wipe off excess lubricant.

TOOLS & ACCESSORIES

GENERAL NOTES:

Cutting Gasket Flange Corners

StanLock does not encourage the practice of cutting the gasket corners to ease glass insertion at the top corners. However, to facilitate glazing in cold weather or where glass clearance is small the following procedure may be followed:

- a. The top two corners may be cut on *interior glazed assemblies only* by first punching a $\frac{3}{16}$ " diameter hole to the glass side of the locking strip.
- b. Cut through flange to the punched holes.
- c. Complete glass setting including setting blocks and spacer strips — if used.
- d. Clean area at cut corner to assure optimum corner seal.
- e. Inject butyl or one-part urethane sealant into punched hole and along cut surface.
- f. Install locking strips.
- g. Wipe off excess sealant.

Cutting corners on the exterior or weather side of the gasket is not recommended. (See note about nipping corners of glass on page 1, section 3.)

Weep Hole Drills

StanLock's punch drills remove a perfect plug without tearing the rubber gasket. Available in $\frac{1}{4}$ " & $\frac{3}{16}$ " diameters.

Part No. 81010260 ($\frac{1}{4}$ "
Part No. 81010261 ($\frac{3}{16}$ "

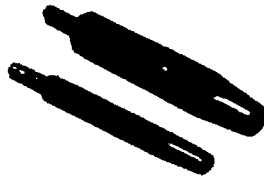

Lockstrip Installation tool

Our Lockstrip installation tool makes the lock strip easier to install than any other installation tool tested by StanLock engineers.

Part No. 81010026



Adapter handle

StanLock offers an adapter which doubles the manual "zipping" power by turning the tool into a two-handed operation. The adapter is affixed to the tool at any angle or position required for maximum push pressure.

Part No. 81010025

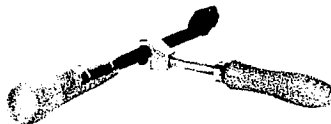

StanLock tool kit

All the necessary tools required for the installation of glazing gaskets are contained in a single package. The kit includes one Lockstrip insertion tool, one adapter handle, one cutter, four spatulas and a copy of these installation instructions.

Part No. 81010023

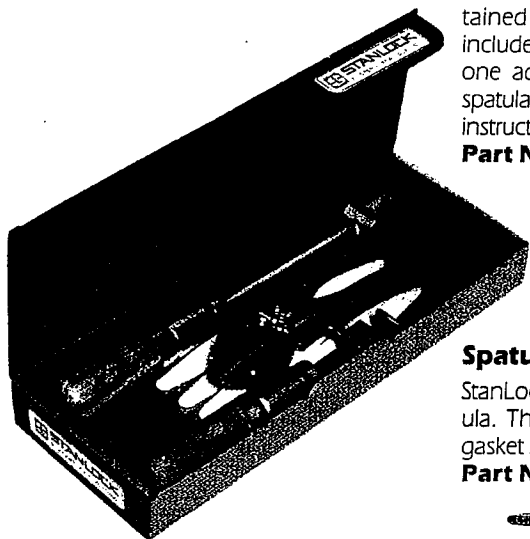

Spatulas

StanLock also supplies an exclusive spatula. This is used (in pairs) to open the gasket lips to insert glass.

Part No. 81010034



Cutter

A cutter for mitering lock strip simplifies the task of making straight or miter cuts.

Part No. 81010045



StanLock lubricant

StanLock lubricant, applied to the locking channel, greatly eases the insertion of lock strips. Being a clear-amber heavy liquid, it will not flow out from the channel at the top and sides when applied.

It also greatly facilitates the installation of glass or panel into the gasket.

All the components of StanLock lubricant are readily water soluble and will wash off in rain. If inside glazed, the gasket can be wiped clean with a cloth, either wet or dry.

StanLock lubricant contains no solvent which could deteriorate the gaskets or cause staining of concrete, aluminum or other light-colored surfaces.

Part No. 81010046



Elastomeric Sealant

StanLock J-106 Elastomeric Sealant is a high performance, vulcanized sealant.

StanLock sealant offers excellent weather-ability. It will not lose flexibility nor harden after prolonged exposure to the elements.

Tack free in hours, it applies easily at low temperatures, and does not string.

Recommended uses . . . For sealing windows or door frames for holding glass, and for sealing joints where continuous movement is not a factor.

NOTE: Other sealants which can be used with neoprene gaskets include one part urethanes and butyl rubber sealants with high solid contents.

Avoid the use of wet silicone sealants with neoprene when the joint will be exposed to ultraviolet light (sunlight).