

NOTES:

- 1) GLASS AS ALL GLASS LAMINATE
- 2) GCP AS GLASS CLAD POLYCARBONATE
- 3) EACH TYPE IS NO SPALL, UL752 RATED AT A MINIMUM WIDTH AND HEIGHT OF 11"

GLASS (NOTE 1)
LEVEL 2

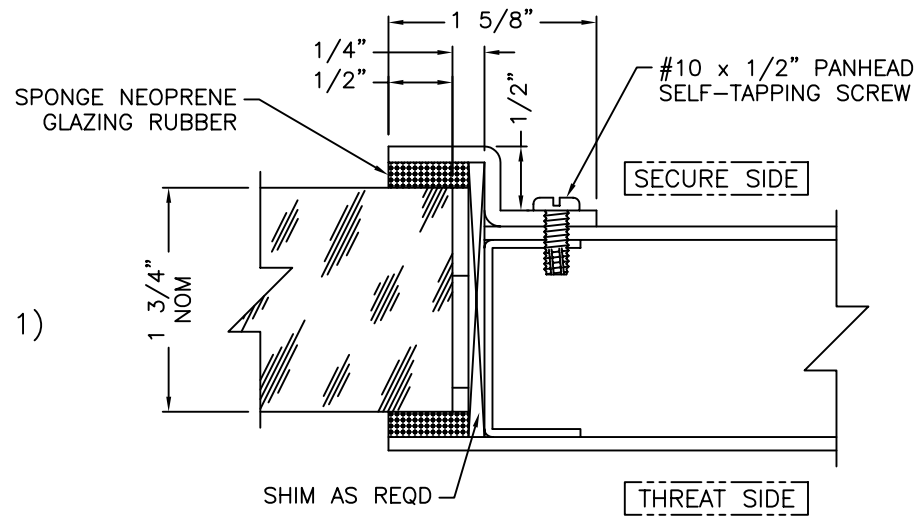

GCP (NOTE 2)
LEVEL 2

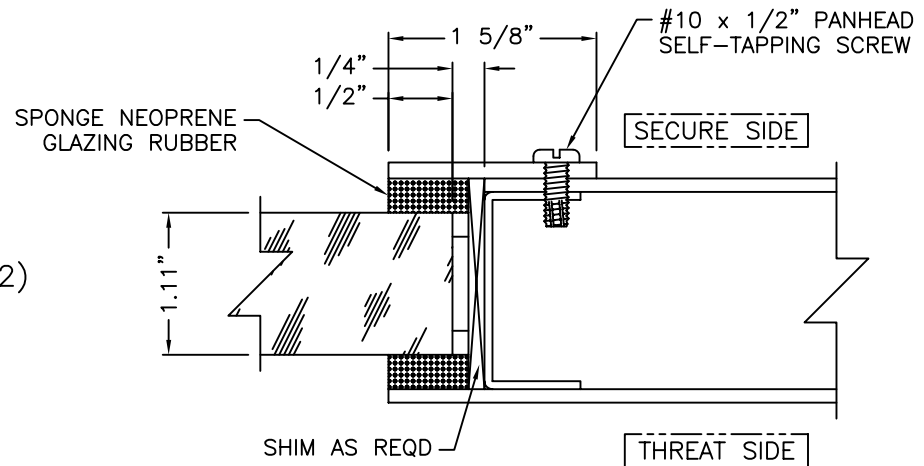

NOTICE

THIS DRAWING AND DESIGN ARE THE PROPERTY OF THE OVERLY DOOR COMPANY. THIS DRAWING IS LOANED TO YOU SUBJECT TO THE CONDITION THAT IT SHALL NOT BE REPRODUCED, COPIED, LOANED OR OTHERWISE DISPOSED OF DIRECTLY OR INDIRECTLY. IT SHALL NOT BE USED TO FURNISH ANY INFORMATION FOR THE MAKING OF DRAWINGS, PRINTS OR APPARATUS, OR PARTS THEREOF, EXCEPT WHERE OTHERWISE SPECIFICALLY PROVIDED FOR BY CONTRACT AGREEMENT WITH THE OVERLY DOOR COMPANY.

**Glazing Detail for Series DFG UL Level 2
Bullet-Resistive Door with Vision Lite**



574 West Otterman Street
Greensburg, PA 15601
Phone: 800-979-7300
Fax: 724-830-2871
Email: overly@overly.com

DO NOT SCALE DRAWING

DRAWN BY/DATE: JMC 10/25/2005

CONTROL NUMBER: DET-137

FILENAME: cut-br-lvl2glz.dwg