

# SERIES

# BRM

# OVERLY

DOOR COMPANY

574 WEST OTTERMAN STREET  
POST OFFICE BOX 70  
GREENSBURG, PA 15601-0070  
TELEPHONE: 724-834-7300  
FAX: 724-830-2871

## UL LEVEL 3 METAL BULLET RESISTANT GLAZING AND ASTRAGAL SYSTEMS

IF GLASS BY OVERLY:  
UL LEVEL 3 GLASS CLAD  
POLYCARBONATE SHIPPED  
LOOSE OR FACTORY INSTALLED

IF GLASS BY OTHERS: GLAZING  
MUST BE UL LEVEL 3, NO  
GREATER THAN 1-1/2" THICK,  
AND THICKNESS SPECIFIED AT  
TIME OF ORDER

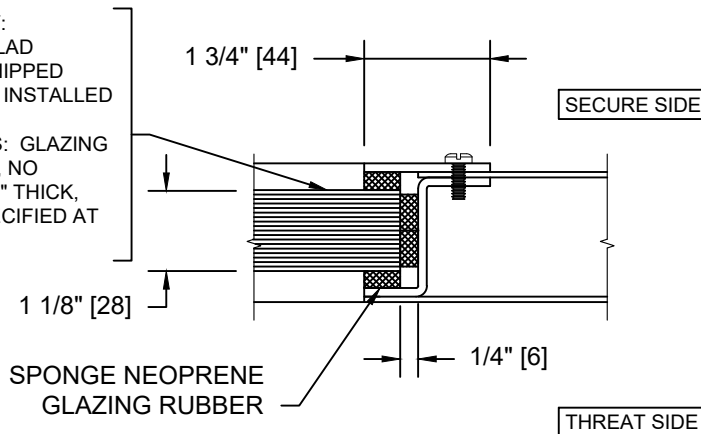

### UL LEVEL 3 GLAZING REQUIREMENTS

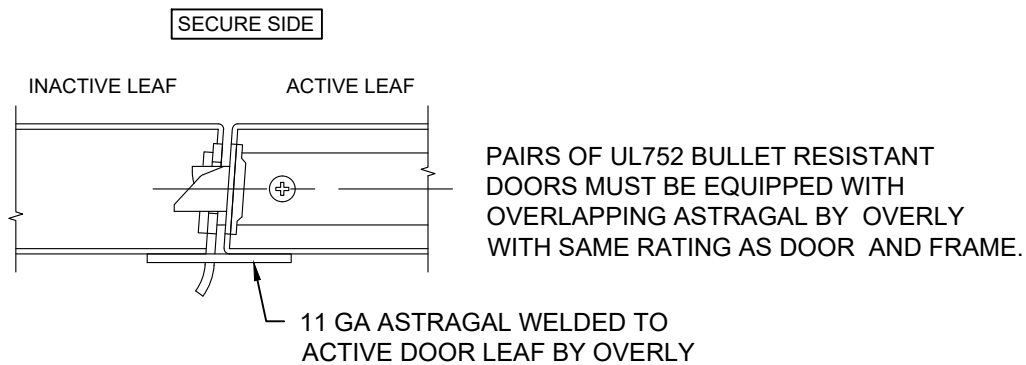

### UL LEVEL 3 ASTRAGAL DETAIL REVERSE BEVEL SWING

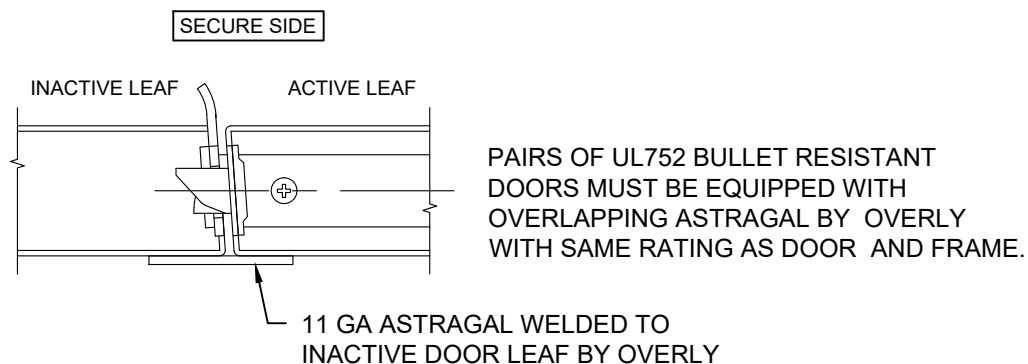

### UL LEVEL 3 ASTRAGAL DETAIL REGULAR SWING