

# SERIES

# BRM

# OVERLY DOOR COMPANY

574 WEST OTTERMAN STREET  
POST OFFICE BOX 70  
GREENSBURG, PA 15601-0070  
TELEPHONE: 724-834-7300  
FAX: 724-830-2871

## UL LEVEL 5 METAL BULLET RESISTANT GLAZING AND ASTRAGAL SYSTEMS

IF GLASS BY OVERLY:  
UL LEVEL 5 GLASS CLAD  
POLYCARBONATE SHIPPED  
LOOSE OR FACTORY INSTALLED

IF GLASS BY OTHERS: GLAZING  
MUST BE UL LEVEL 5, NO  
GREATER THAN 1-1/2" THICK,  
AND THICKNESS SPECIFIED AT  
TIME OF ORDER

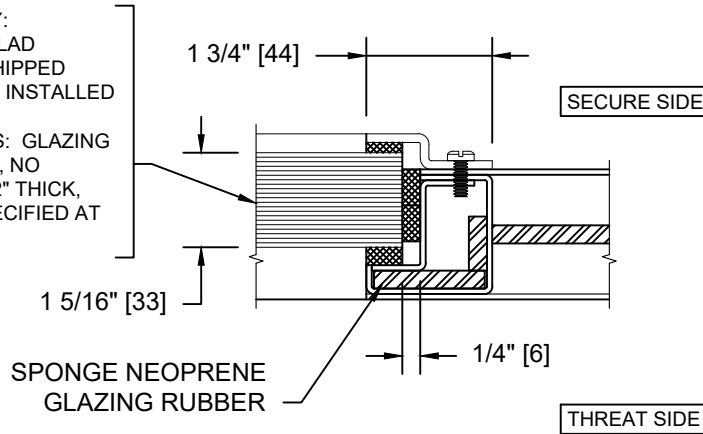

### UL LEVEL 5 GLAZING REQUIREMENTS

SECURE SIDE

INACTIVE LEAF      ACTIVE LEAF

THREAT SIDE

1 1/8" [28]  
MAX STRIKE  
LIP

15/16" [24]

11 GA ASTRAGAL WITH BR LINER  
WELDED TO ACTIVE DOOR LEAF  
BY OVERLY

PAIRS OF UL752 BULLET RESISTANT  
DOORS MUST BE EQUIPPED WITH  
OVERLAPPING ASTRAGAL BY OVERLY  
WITH SAME RATING AS DOOR AND FRAME.

### UL LEVEL 5 ASTRAGAL DETAIL REVERSE BEVEL SWING

INACTIVE LEAF      ACTIVE LEAF

SECURE SIDE

THREAT SIDE

11 GA ASTRAGAL WITH BR LINER  
WELDED TO ACTIVE DOOR LEAF  
BY OVERLY

1 1/16" [27]

PAIRS OF UL752 BULLET RESISTANT  
DOORS MUST BE EQUIPPED WITH  
OVERLAPPING ASTRAGAL BY OVERLY  
WITH SAME RATING AS DOOR AND FRAME.

### UL LEVEL 5 ASTRAGAL DETAIL REGULAR SWING